

Thank you for choosing this MOJOGEAR MG-35-T tripod. Please read this manual before use. If you have any additional questions, feel free to contact us at [support@mojogear.eu](mailto:support@mojogear.eu).

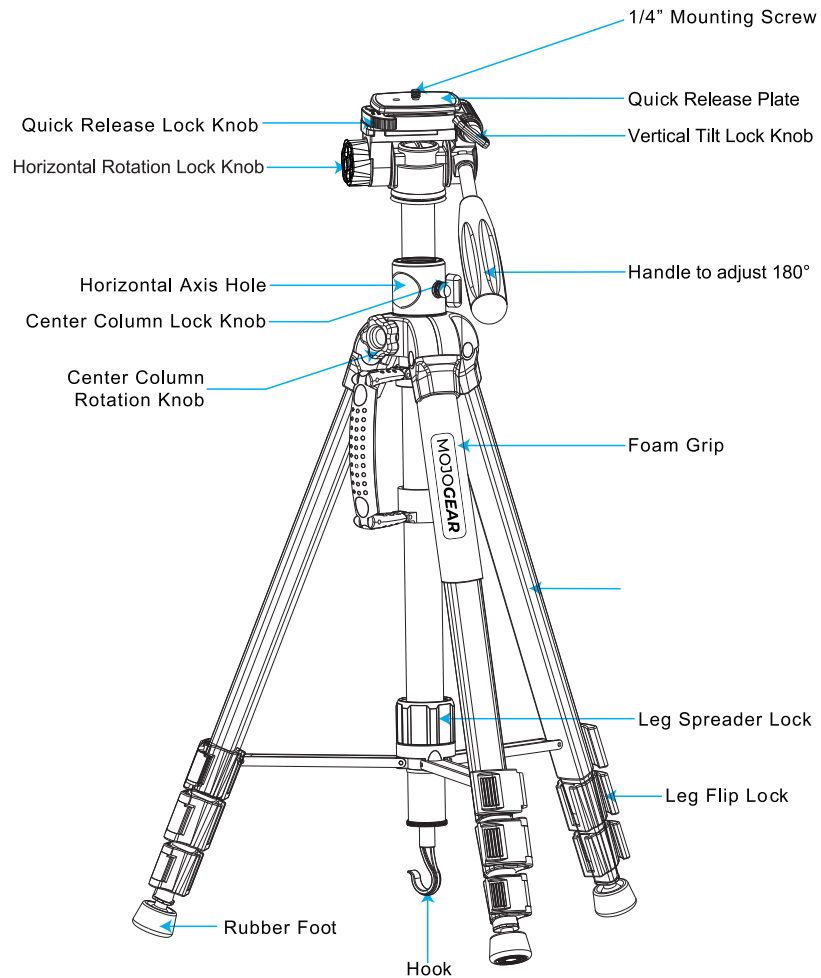

### SPECIFICATIONS:



1/4" screw



Net weight: 1.4 kg



Load capacity: 3 kg



Folded Height: 56 cm



Minimum Height: 54 cm



Maximum Height: 167 cm



23 mm 4-section aluminum legs

## Adjust height

Use the center column to adjust the height.

Lock the center column lock knob to secure the height.

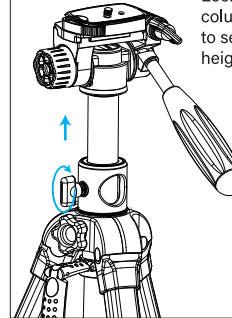

## Quick release plate

Open the quick release lock knob to remove the quick release plate.

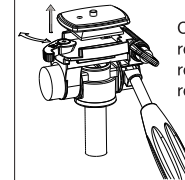

## Tilt for vertical shots

You can move the tripod head in 3 directions.

To tilt the head (for example to make vertical shots), loosen the vertical tilt lock knob.

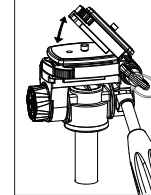

## Lock the legs

Open the flip-lock to adjust the length of the legs. Close it to secure the legs.

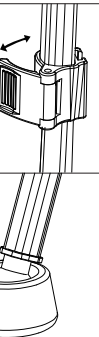

## Rubber feet

With the integrated anti-slip rubber feet, you can easily place the tripod on any surface.

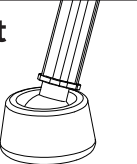

## Hook

For extra stability, you can attach some weight (for example a bag) to the hook.

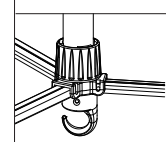

## Monopod

Detach the center column to use it as a monopod or selfie stick.

Locking

To detach the monopod, loosen the center column lock knob and pull up the center column until it comes out.

To adjust the length of the monopod, rotate the rubber foot clockwise. Rotate counterclockwise to secure in position.

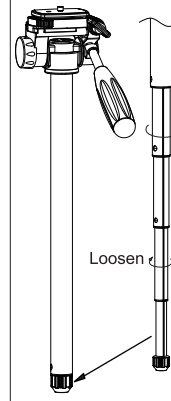

## Horizontal center column

After detaching the center column, put it through the horizontal axis hole to use horizontally.

Loosen the rotation knob to rotate the horizontal axis.

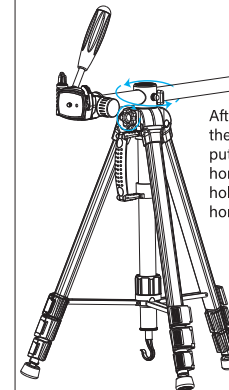

## Phone clamp

With the included MOJOGEAR premium phone clamp you can easily mount your phone to the tripod.

You can use the cold shoe mount on top of the phone clamp to mount an accessory (e.g. microphone, LED light).

